



Type 2+3 AC surge protector - one-phase - pluggable

CITEL

DS41VG-230



- ↳ Discover our latest innovation : the [DAC50VG-10-275](#)
- ↳ Type 2 + 3 AC surge protector
- ↳ In : 20 kA
- ↳ Imax : 40 kA
- ↳ Pluggable module
- ↳ Follow and operating current : none
- ↳ No ageing
- ↳ Optional remote signaling state
- ↳ Optimized to TOV
- ↳ EN 61643-11, IEC 61643-11, UL1449 ed.5 compliance

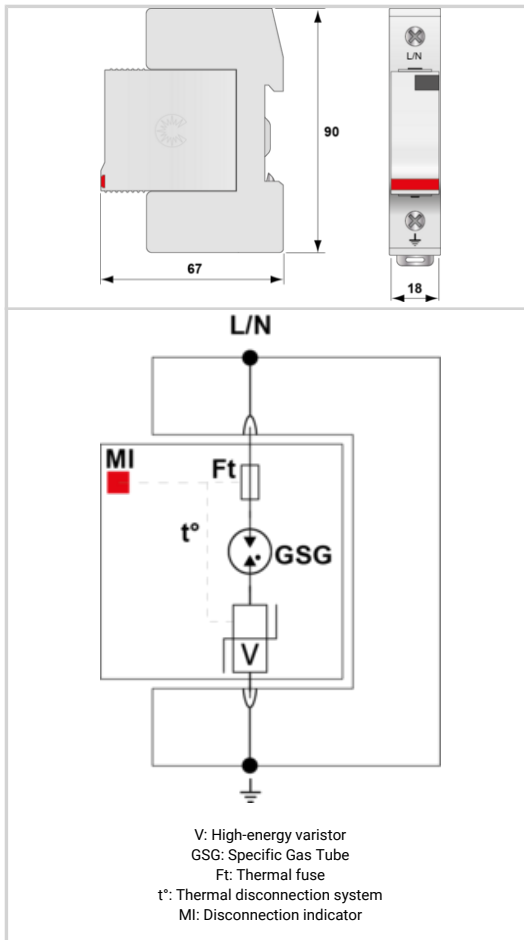

Electrical Characteristics		
SPD type		2+3
Network		230/400 V
Nominal line voltage	Un	230 Vac
Max. AC operating voltage	Uc	255 Vac
Temporary Over Voltage (TOV) Characteristics - 5 sec. Without disconnection	UT	335 Vac withstand
Temporary Over Voltage (TOV) Characteristics - 120 mn Without disconnection or with safety disconnection	UT	440 Vac withstand
Residual Current	Ipe	None
Leakage current to Ground		
Follow current	If	None
Nominal discharge current 15 x 8/20 μs impulses	In	20 kA
Max. discharge current max. withstand @ 8/20 μs by pole	Imax	40 kA
Withstand on Combination waveform IEC 61643-11 Class III test: 1.2/50μs - 8/20μs	Uoc	6 kV
Withstand on overvoltages IEEE C62.41.1		20 kV
Connection mode(s)		L/N or N/PE
Protection mode(s)		Common Mode or Differential Mode
Protection level @ In (8/20μs)	Up	1.25 kV
Residual voltage @ In (8/20 μs)	Up-in	0.8 kV
Admissible short-circuit current	Iscrr	25 000 A
Mechanical Characteristics		
Technology		VG Technology (MOV+GSG)
SPD configuration		Single phase
Connection to Network		By screw terminals: 2.5-25mm ² / by bus
Format		Plug-in modular box
Mounting		Symmetrical rail 35 mm (EN 60715)
Housing material		Thermoplastic UL94 V-0
Operating temperature	Tu	-40/+85°C
Protection rating		IP20
Failsafe mode		Disconnection from AC network
Disconnection indicator		1 mechanical indicator
Spare module(s)		DSM40VG-230
Remote signaling of disconnection		option DS41VGs-230 : output on changeover contact
Dimensions		See diagram
Disconnectors		
Thermal disconnector		Internal
Installation ground fault breaker		Type 'S' or delayed
Back-up protection device		50 A min. - 125 A max. - Fuses Type gG
Standards		
Standards compliance		IEC 61643-11 / EN 61643-11 / UL1449 ed.5
Certification		UL Recognized
Part number		
331751		

