



CITEL

Type 1+2+3 AC surge protector - 3-phase+N

DACN1-25CVGS-31-150



- Type 1 + 2+3 AC surge protector
- VG Technology
- Iimp: 25 kA on 10/350µs impulse
- In: 25 kA
- Optimized to TOV
- No leakage current
- Monobloc
- Remote signaling
- EN 61643-11, IEC 61643-11 Certified

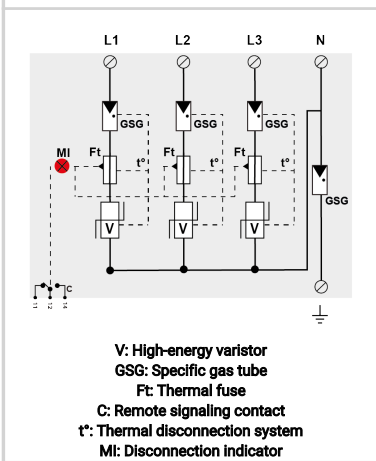
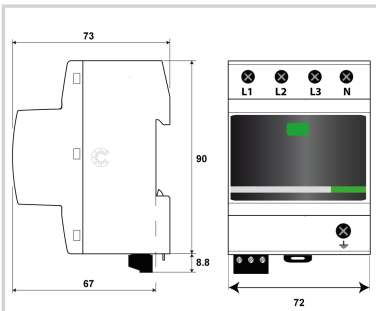

Electrical Characteristics

SPD type	IEC	1+2+3
Network		120/208 V 3-phase+N
AC system		TT-TNS
Max. AC operating voltage	Uc	150 Vac
Temporary Over Voltage (TOV) Characteristics - 5 sec. Without disconnection	UT	180 Vac withstand
Temporary Over Voltage (TOV) Characteristics - 120 mn Without disconnection or with safety disconnection	UT	230 Vac withstand
Temporary Over Voltage N/PE (TOV HT) Without disconnection or with safety disconnection	UT	1200 V/300A/200 ms withstand
Residual Current		
Leakage current to Ground	Ipe	None
Follow current	If	None
Nominal discharge current 15 x 8/20 µs impulses	In	25 kA
Nominal discharge current N/PE 15 x 8/20 µs impulses	In N/PE	100 kA
Max. discharge current max. withstand @ 8/20 µs by pole	Imax	100 kA
Max. discharge current N/PE max. withstand @ 8/20 µs by pole	Imax N /PE	100 kA
Impulse current by pole max. withstand 10/350µs by pole	Iimp	25 kA
Total lightning current max. total withstand @ 10/350µs	Itotal	100 kA
Withstand on Combination waveform IEC 61643-11 Class III test: 1.2/50µs - 8/20µs	Uoc	6 kV
Protection level L/N @ In (8/20µs)	Up L/N	1.5 kV
Protection level N/PE @ In (8/20µs)	Up N/PE	1.5 kV
Admissible short-circuit current	Iscrr	50 000 A

Mechanical Characteristics

Technology		VG Technology (MOV+GSG)
SPD configuration		3-phase+Neutral
Connection to Network		By screw terminals: 2.5-25mm ² (35mm ² rigid)
Format		Monobloc modular box
Mounting		Symmetrical rail 35 mm (EN 60715)
Housing material		Thermoplastic UL94 V-0
Operating temperature	Tu	-40/+85°C
Protection rating		IP20
Failsafe mode		Disconnection from AC network
Disconnection indicator		1 mechanical indicator - Red/Green
Remote signaling of disconnection		Output on changeover contact
Wiring for remote signaling		1.5 mm ² max.
Max. Voltage/Current for remote signaling		250 V / 0.5 A (AC) / 30 V / 3 A (DC)

Disconnectors

Thermal disconnector		Internal
Installation ground fault breaker		Type 'S' or delayed
Back-up protection device		315 A max. - Fuses Type gG / or SFD1-25S

Standards

Standards compliance		EN 61643-11 / IEC 61643-11
Certification		KEMA

Part number

64152

