



# CITEL

## Isolating spark gap (ISG)

### BF PS 350/20



- › Isolating spark gap
- › Outdoor application
- › Max. discharge current: 100 kA
- › EN 62561-3 compliance

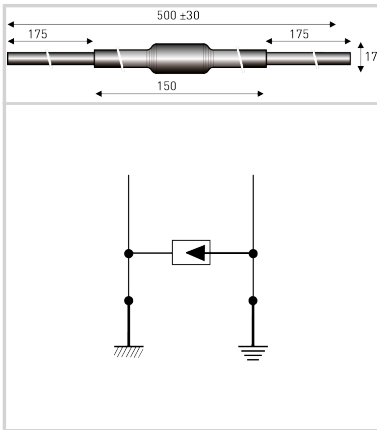

#### Electrical Characteristics

Rated DC withstand voltage	Uw DC	280 V
Rated AC withstand voltage	Uw AC	190 V
Max. discharge current <i>max. withstand @ 8/20 μs by pole</i>	Imax	100 kA
Impulse current by pole <i>max. withstand 10/350 μs by pole</i>	Iimp	50 kA
Classification following IEC 62561-3		N

#### Mechanical Characteristics

Technology		Gas discharge tube
Connection to Network		Wire
Operating temperature	Tu	-40/+85°C
Protection rating		IP67
Number of units per package		1 unit per packaging
Dimensions		See diagram

#### Standards

Standards compliance		EN 62561-3
RohS compliance		Yes

#### Part number

90231615

