



CITEL



DC power surge protector - 95 Vdc

DS240-95DC

- Discover our latest innovation : the [DDC40C-20-125](#)
- DC or PV power surge protector
- 95 Vdc
- Compact design
- I_{max}: 40 kA
- Pluggable module
- Remote signaling (option)
- Very low Up protection level

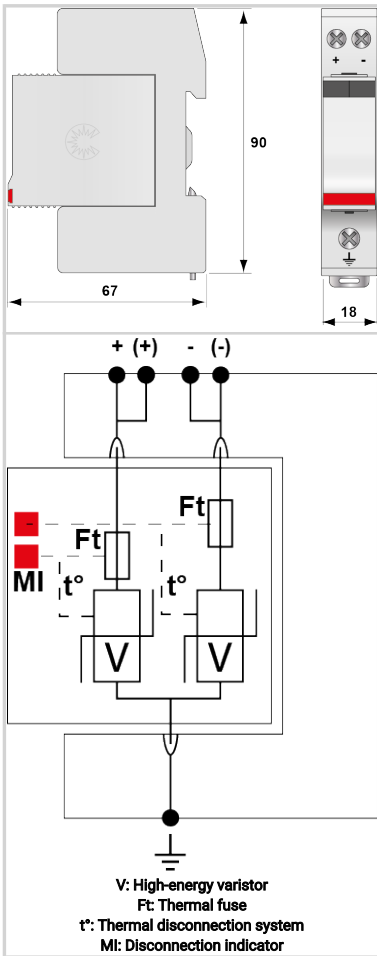

Electrical Characteristics

SPD type	IEC	2
Network		DC or PV network 95Vdc
Nominal DC voltage	Un-dc	95 Vdc
Nominal PV voltage	Uocstc	95 Vdc
Max. AC operating voltage	Uc	95 Vac
Max. PV operating voltage	Ucpv	125 Vdc
Max. DC operating voltage	Uc	125 Vdc
Max. load current @25°C	IL	50 A
Residual Current Leakage current to Ground	Ipe	< 0.2 mA
PV Permanent Operating current Current consumption at Ucpv	Icpv	< 0.1 mA
Follow current	If	None
Nominal discharge current 15 x 8/20 μs impulses	In	20 kA
Max. discharge current max. withstand @ 8/20 μs by pole	I _{max}	40 kA
Total Maximum discharge current max. total withstand @ 8/20 μs	I _{max} Total	80 kA
Current withstand short circuit PV	Iscpv	1000 A
Connection mode(s)		+/-/PE
Protection mode(s)		Common mode
Protection level +/-PE (-/PE) @ In (8/20μs)	Up	450 V

Mechanical Characteristics

Technology		MOV
SPD configuration		2-poles
Connection to Network		By screw terminals: 1.5-10mm ² (actives wires) and 2.5-25mm ² (ground)
Format		Plug-in modular box
Mounting		Symmetrical rail 35 mm (EN 60715)
Housing material		Thermoplastic UL94 V-0
Operating temperature	Tu	-40/+85°C
Protection rating		IP20
Failsafe mode		Disconnection from DC network
Disconnection indicator		2 mechanical indicators
Spare module(s)		DSM240-95DC
Remote signaling of disconnection		Option DS240S-95DC : output on changeover contact
Dimensions		See diagram

Disconnectors

Thermal disconnector		Internal
Back-up protection device		Fuses type gG - 20A

Standards

Standards compliance		IEC 61643-11 / EN 61643-11 / UL1449 ed.5
Certification		UL Recognized

Part number

310301

